

ONYX-175S/195S

17"/19" Intel Core 2 Duo

Processor

High Performance

Low Power Consumption

Medical Station

ONYX-175S/195S Manual 2st Ed

September, 2010

Copyright Notice

This document is copyrighted, 2010. All rights are reserved. The original manufacturer reserves the right to make improvements to the products described in this manual at any time without notice.

No part of this manual may be reproduced, copied, translated, or transmitted in any form or by any means without the prior written permission of the original manufacturer. Information provided in this manual is intended to be accurate and reliable. However, the original manufacturer assumes no responsibility for its use, nor for any infringements upon the rights of third parties, which may result from its use.

The material in this document is for product information only and is subject to change without notice. While reasonable efforts have been made in the preparation of this document to assure its accuracy, ONYX Healthcare Inc., assumes no liabilities resulting from errors or omissions in this document, or from the use of the information contained herein

ONYX Healthcare Inc. reserves the right to make changes in the product design without notice to its users

Acknowledgments

- Intel® and Core 2 Duo and Core Solo are registered trademarks of Intel® Corporation.
- IBM, PC/AT, PS/2 are trademarks of International Business Machines Corporation.
- Microsoft® Windows is a registered trademark of Microsoft® Corporation.
- RTL is a trademark of Realtek Semi-Conductor Co., Ltd.
- C&T is a trademark of Chips and Technologies, Inc.
- UMC is a trademark of United Microelectronics Corporation.
- ITE is a trademark of Integrated Technology Express, Inc.
- SiS is a trademark of Silicon Integrated Systems Corp.
- VIA is a trademark of VIA Technology, Inc.

All other product names or trademarks are properties of their respective owners.

Packing List

Before you begin installing your Medical Station, please make sure that the following items have been shipped:

- Onyx-175S or ONYX-195S Super Medical Station
- HDD screws
- Utility CD-ROM (Please insert the ONYX-175S/195S CD-ROM into external CD-ROM drive.) which Contains User's Manual (in PDF format), Drivers and Utilities

If any of these items are missing or damaged, you should contact your distributor or sales representative immediately.

Headquarters

Onyx Healthcare Inc.

2F, No.135, Lane 235, Pao-Chiao Rd.,

Hsin-Tien City, Taipei 231, Taiwan, R.O.C.

TEL: +886-2-8919-2188

FAX: +886-2-8919-1699

E-mail: sales@onyx-healthcare.com

<http://www.onyx-healthcare.com>

Worldwide Offices:

Onyx Healthcare, USA Inc.

2663 Saturn street, Brea, CA 92821, USA

Tel : +1-714-996-1800

Fax: +1-714-996-1811

Email: usasales@onyx-healthcare.com

Onyx Healthcare EUROPE B.V.

Ekkersrijt 4002, 5692 DA Son, The Netherlands

Tel : +31-(0)499-462020

Fax: +31-(0)499-462010

Email: eusales@onyx-healthcare.com

Onyx Healthcare Technology GmbH

An der Trift65d

63303 Dreieich , Germany

TEL: +49-(0)61033-7479-00

Fax: +49-(0)61033-7479-49

Email: eusales@onyx-healthcare.com

Medical Station

ONYX-175S/195S

Onyx Healthcare (SU ZHOU) INC.

Room 12, 2F, Building B, No.5 Xing Han Street, Suzhou Industrial
Park, Jiang Su Province, China

Tel: +86-512-67625700

Fax: +86-512-67617337

Email: cnsales@onyx-healthcare.com

Onyx Healthcare Singapore PTE LTD

57 Genting Lane, #07-00, Singapore 349564

Tel: +65-67498749

Fax +65-67461595

Email: sgsales@onyx-healthcare.com

Safety & Warranty

1. Read these safety instructions carefully.
2. Keep this user's manual for later reference.
3. Disconnect this equipment from any AC outlet before cleaning. Do not use liquid or spray detergents for cleaning. Use a damp cloth.
4. For pluggable equipment, the power outlet must be installed near the equipment and must be easily accessible.
5. Keep this equipment away from humidity.
6. Put this equipment on a reliable surface during installation. Dropping it or letting it fall could cause damage.
7. The openings on the enclosure are for air convection. Protect the equipment from overheating. **DO NOT COVER THE OPENINGS.**
- 8. Make sure the voltage of the power source is correct before connecting the equipment to the power outlet.**
9. Position the power cord so that people cannot step on it. Do not place anything over the power cord.
10. All cautions and warnings on the equipment should be noted.
11. If the equipment is not used for a long time, disconnect it from the power source to avoid damage by transient over-voltage.
12. Never pour any liquid into an opening. This could cause fire or electrical shock.
13. Never open the equipment. For safety reasons, only qualified

Medical Station

ONYX-175S/195S

service personnel should open the equipment.

- 14. If any of the following situations arises, get the equipment checked by service personnel:**
- The power cord or plug is damaged.
 - Liquid has penetrated into the equipment.
 - The equipment has been exposed to moisture.
 - The equipment does not work well, or you cannot get it to work according to the users manual.
 - The equipment has been dropped and damaged.
 - The equipment has obvious signs of breakage.
- 15. DO NOT LEAVE THIS EQUIPMENT IN AN UNCONTROLLED ENVIRONMENT WHERE THE STORAGE TEMPERATURE IS BELOW -20° C (-4°F) OR ABOVE 60° C (140° F). IT MAY DAMAGE THE EQUIPMENT.**
- 16. External equipment intended for connection to signal input/output or other connectors, shall comply with relevant UL / IEC standard (e.g. UL 1950 for IT equipment and UL 60601-1 / IEC 60601 series for systems – shall comply with the standard IEC 60601-1-1, Safety requirements for medical electrical systems. Equipment not complying with UL 60601-1 shall be kept outside the patient environment, as defined in the standard.**

Caution:

It may cause the danger of explosion if battery is incorrectly replaced. Replace only with same or equivalent type recommended by the manufacturer.

Classification

1. Degree of protection against electric shock: not classified
2. Degree of protection against the ingress of water: IPX0
3. Equipment not suitable for use in the presence of a flammable anesthetic mixture with air or with oxygen or nitrous oxide.
4. Mode of operation: Continuous
5. Type of protection against electric shock: Class I equipment

FCC Safety

Warning!



This device complies with Part 15 FCC Rules. Operation is subject to the following two conditions: (1) this device may not cause harmful interference, and (2) this device must accept any interference received including interference that may cause undesired operation.





UL Module Description



Onyx-175S/195S AC modules are developed to suitable for the Classification Mark requirement

Safety Symbol Description

The following safety symbols are the further explanations for your reference.

	<p><i>Medical equipment with respect to electric shock, fire and mechanical hazards only in accordance with UL 60601-1, and CAN/CSA C22.2 NO. 601.1</i></p>
	<p><i>Attention, consult ACCOMPANYING DOCUMENTS.</i></p>
	<p><i>Ground wire Protective Ground wire.</i></p>
	<p><i>Medical equipment with respect to electric shock, fire and mechanical hazards only in accordance with UL 60601-1, and CAN/CSA C22.2 NO. 601.1</i></p>

Below Table for China RoHS Requirements

产品中有毒有害物质或元素名称及含量

ONYX Panel PC/ Workstation

部件名称	有毒有害物质或元素					
	铅 (Pb)	汞 (Hg)	镉 (Cd)	六价铬 (Cr(VI))	多溴联苯 (PBB)	多溴二苯醚 (PBDE)
印刷电路板 及其电子组件	×	○	○	○	○	○
外部信号 连接器及线材	×	○	○	○	○	○
外壳	×	○	○	○	○	○
中央处理器 与内存	×	○	○	○	○	○
硬盘	×	○	○	○	○	○
液晶模块	×	○	○	○	○	○
光驱	×	○	○	○	○	○
触控模块	×	○	○	○	○	○
电源	×	○	○	○	○	○

O: 表示该有毒有害物质在该部件所有均质材料中的含量均在
SJ/T 11363-2006 标准规定的限量要求以下。

X: 表示该有毒有害物质至少在该部件的某一均质材料中的含量超出
SJ/T 11363-2006 标准规定的限量要求。

备注:

- 一、此产品所标示之环保使用期限，系指在一般正常使用状况下。
- 二、上述部件物质中央处理器、内存、硬盘、光驱、触控模块为选购品。

Contents

Chapter 1 General Information

1.1 Introduction	1-1
1.2 Feature.....	1-3
1.3 Specification	1-4
1.4 Dimension.....	1-8

Chapter 2 Hardware Installation

2.1 Safety Precautions	2-2
2.2 A Quick Tour of the ONYX-175/195.....	2-3
2.3 Removing the rear maintenance cover	2-6
2.4 2.5” Hard Disk Drive (HDD) Installation.....	2-6
2.5 COM5 RS-232/422/485 Selection.....	2-9
2.6 RS-232/422/485 Serial Port Connector	2-9

Chapter 3 Award BIOS Setup

3.1 System Test and Initialization... ..	3-2
3.2 Award BIOS Setup.	3-3

Chapter 4 Driver Installation

4.1 Installation.....	4-3
4.2 Card Reader Driver Installation	4-4
4.3 Touch Screen Driver Installation	4-4
4.4 Smart Card Driver Installation.....	4-4
4.5 RFID Driver Installation.....	4-5

Appendix A Programming the Watchdog Timer

A.1 Programming	A-2
A.2 IT8712 Watchdog Timer Initial Program	A-6

Appendix B I/O Information

B.1 I/O Address Map.....	B-2
B.2 Memory Address Map.....	B-3
B.3 IRQ Mapping Chart	B-4
B.4 DMA Channel Assignments	B-4

Appendix C Miscellanea

C.1 General Cleaning Tips.....	C-2
C.2 Cleaning Tools.....	C-3
C.3 Scrap Computer Recycling	C-5

Chapter

1

**General
Information**

1.1 Introduction

The ONYX-175S/195S Medical Stations are based on Intel Core 2 Duo processors which deliver a performance improvement of more than 100% compared to systems running traditional single-core processors. With two cores, or computing engines, ONYX can simultaneously execute two computing tasks. It accommodates one 2.5" SATA hard disk drive and up to 2GB DDR SODIM.

The high brightness LCD, Low Noise solution, integrated multimedia functions and extensive expansion options make them the perfect platform upon which to build comprehensive surgical computing applications.

The ONYX-175S/195S includes all the features of a powerful computer into a slim chassis. The ONYX-175S/195S have 17"/19" high brightness TFT display with 1280 x 1024 resolutions for easier DICOM image analysis. This model is equipped with side slim 8-in-card reader, slim DVD ROM, and smart card reader to support vivid storage read/write and ID check by smart card reader. The most important function of the ONYX-175S/195S is the isolated COM ports design.

Combining the ONYX-175S/195S into your system can achieve both cost-saving and efficiency improvements. Common

applications include Surgical, Radiology, PACS (Picture Archiving Communication Systems), LIS (Lab Information Systems) and Electronic Medical Record. The ONYX-175S/195S are definitely your perfect choices.

1.2 Feature

- 17"/ 19" Intel Core 2 Duo Processor
- 300 nits high brightness to X-ray films
- Latex-free
- Two Isolation COM Ports
- Built-in RFID and Finger Printer Security (Optional)
- Mini capture card support Non-DICOM CAM to DICOM (optional)
- PCI Expansion
- Highest performance and low power system solution
- 802.11g/b/g and Bluetooth Wireless Solution (optional)
- Plastic construction with medical outlook color

1.3 Specification

Hardware Specifications

Display	ONYX-175S: 17" SXGA color TFT LCD ONYX-195S: 19" SXGA color TFT LCD
CPU Board	Intel® Core 2 Duo up to 2.16GHz Processor
Disk Drive Space	2.5" SATA Hard Disk Drive (optional) Slim CD/DVD-ROM (optional) 8 in 1 card reader Smart Card reader (optional)
Expansion	One Mini PCI slot; One PCI expansion
Button	Brightness: "+" / "-"; Sound: "+" / "-"; Power SW
I/O	2 Isolated RS-232 , 1 RS-232 , 1 RS232 /422 / 485 8 USB 2.0 ports (5 External , 3 Internal) 1 parallel port 1 PS/2 keyboard and 1 PS/2 mouse 2 Gigabit LAN RJ-45 Connectors <i>Sound:</i> 1 Line-in 1 Line-out 1 Mic-in 2 2W Speakers on back side 1 Video/ S-Video out 1 Video/ S-Video in (optional by capture card)

LCD Specifications

Model Name	ONYX-175S series	ONYX-195S series
Display Type	17" color TFT LCD	19" color TFT LCD
Max. Resolution	1280 x 1024	1280 x 1024
Max. Colors	16.7M	16.7M
Dot Size (mm)	0.297 x 0.297	0.294 x 0.294
Luminance (cd/m²)	380 (TYP)	300 (TYP)
Viewing Angle	150°(H) 130°(V)	140°(H) 135°(V)
Contrast Ratio	500:1	550:1
Operating Temperature	0°C~ 40°C (32°F~104°F)	0°C~ 40°C (32°F~104°F)
Brightness Control	Yes	Yes
Back Light MTBF	50,000 Hrs	50,000 Hrs

Note:

All ONYX's LCD products are manufactured with High precision technology. However, there are a small number of defective pixels in all LCD panels that are not able to change color. This is a normal occurrence for all LCD displays from all manufacturers and should not be noticeable or objectionable under normal operation. ONYX LCD panels are qualified for industry standard conditions in the following: total 7 dead pixels on a screen or if there are 3 within 1 inch square area of each other on the display.

Mechanical Specifications

Architecture	Close-frame
Front Bezel	Plastic bezel with resistive touch screen
Color	Blue-white (Sky series)
Mounting / Holder	VESA 75/100mm
Construction	3mm ABS + PC TYPE Plastic housing
Dimension (W xHxD)	18.1" x 15.2" x 3.8" (460mm x 385mm x 97 mm)
Carton Dimension	23.8" x 9.1" x 24" (605mm x 230mm x 610mm)
Net Weight	ONYX-175S: 18.48 lb (8.4 kg) ONYX-195S: 18.7 lb (8.5 kg)
Gross Weight	ONYX-175S: 21.16 lb (9.62 kg) ONYX-195S: 22 lb (10 kg)
Packing Filler	PE

Power Supply Specifications

Power	AC Model: ONYX-175S:180W ONYX-195S:180W
Input Voltage	AC Model: (input power rating) 100~240 V AC, 2A/1A max. @ 50 ~ 63 Hz
Output Voltages	AC Model: +5 V@12 A, +12 V@12 A, +3.3 V@16.8 A, +5 Vsb@ 2.0 A, -12V @ 0.8A
MTBF	100,000 hrs operation at 25°C

Environmental Specifications

Operating Temperature	0°C to 40°C (32°F ~104°F)
Storage Temperature	-20°C to 60°C (-4°F ~140°F)
Storage Humidity	5% to 95%@ 40°C, non-condensing
Vibration	0.5G / 5 ~ 500Hz (Random) / operation
Shock	15G peak acceleration (11 msec. duration) / operation
Drop	76cm (1 Corner, 3 Edge, 6 Surface)
EMI / Safety	CE / FCC Class B/UL 60601-1/EN 60601-1
IP	Front bezel, IP-65 Certified
Noise	35db (full operation)
Input Power Rating	100~240V/47~63Hz, 2A/1A
Power Consumption	103 W

TouchScreen (Optional)

Type	5-wire, Analog Resistive
Interface	RS-232 interface
Resolution	2048 x 2048
Light Transmission	> 75%
Life Time	35 million activations

1.4 Dimension

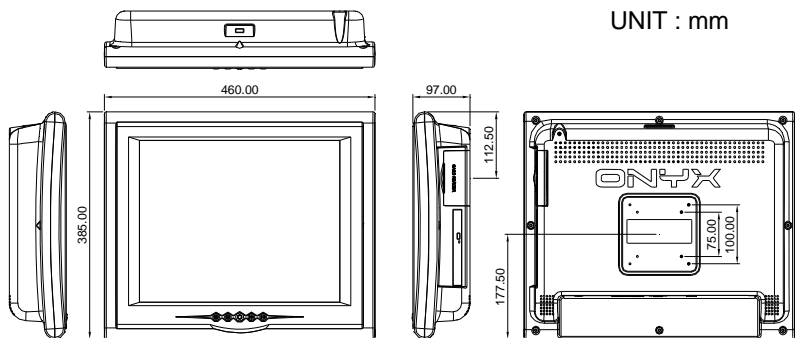

ONYX-175S

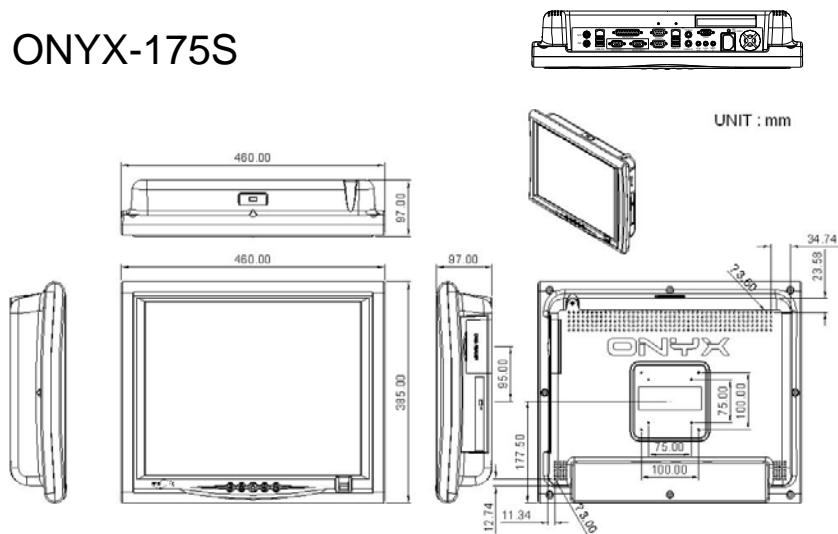

ONYX-195S

Chapter

2

**Hardware
Installation**

2.1 Safety Precautions

Warning!

Always completely disconnect the power cord from your board whenever you are working on it. Do not make connections while the power is on, because a sudden rush of power can damage sensitive electronic components.

Caution!

Always ground yourself to remove any static charge before touching the board. Modern electronic devices are very sensitive to static electric charges. Use a grounding wrist strap at all times. Place all electronic components on a static-dissipative surface or in a static-shielded bag when they are not in the chassis

2.2 A Quick Tour of the ONYX-175S/195S

Before you start to set up the ONYX-175S/195S, take a moment to become familiar with the locations and purposes of the controls, drives, connections and ports, which are illustrated in the figures below.

When you place the ONYX-175S/195S upright on the desktop, its front panel appears as shown in Picture 2-1.

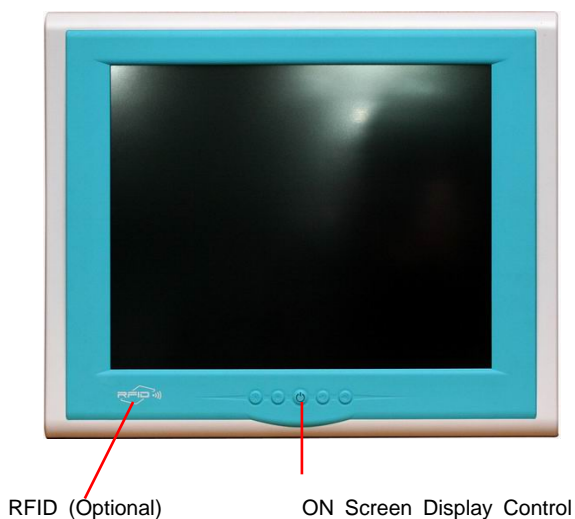

Picture 2.1: Front View of the Medical Station

When you turn the Medical Station around and look at its rear cover, the sunken I/O section is at the bottom of the station, as shown in Picture 2-2. (The I/O section includes various I/O ports, including serial ports, VGA port, the Ethernet port, USB ports, the microphone jack, PCI slot, and so on.) The S-video in option function will need Mini PCI slot. Only assemble with the Mini PCI capture card; the S-Video in function will work. The medical Station integrates with WLAN function by using Mini PCI.



Picture 2.2: Rear view of the Medical Station

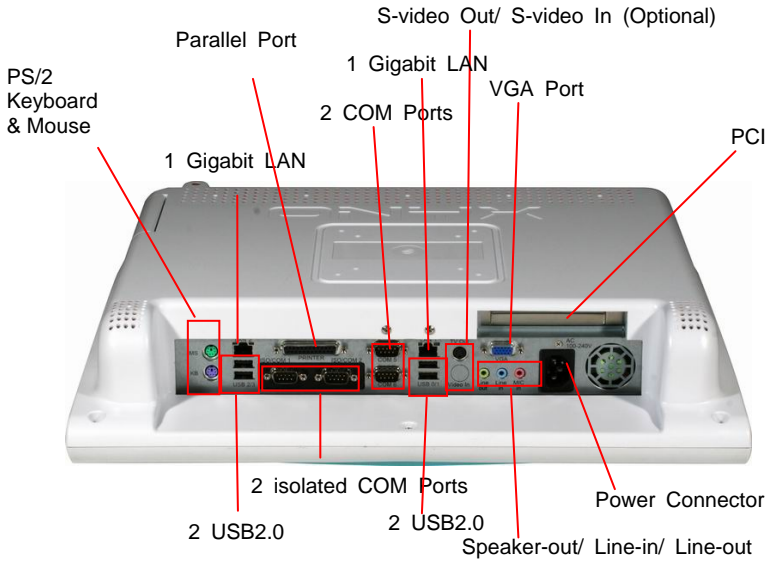

When you turn the Medical Station around and look at its left side, the smart card reader, all in one card reader, and DVD ROM are on the left side of the Medical Station as shown in Picture 2-3.



Picture 2.3: Left view of the Medical Station

2.3 Removing the rear maintenance cover

Pull USB cover; unscrew the attachment screws used to hold the rear maintenance cover and remove rear cover.

2.4 2.5" Hard Disk Drive (HDD) Installation

1. Unscrew the rear cover screws.

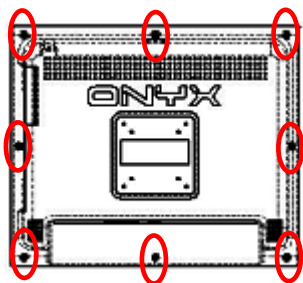

2. Unscrew the rear screws.



3. Remove rear cover and unscrew the disk module screws.

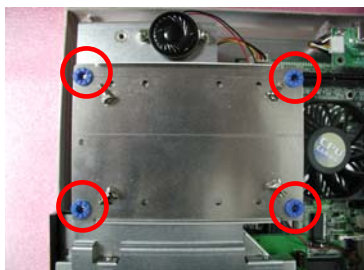

4. Lay the HDD over the HDD bracket and fasten the four screws



5. Fasten the five screws to fix the HDD

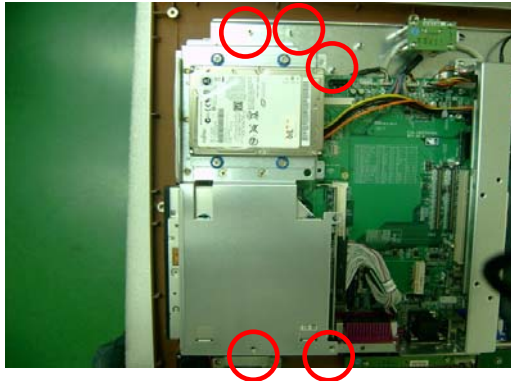

6. Insert one side connector of SATA Cable to the SATA socket on main board

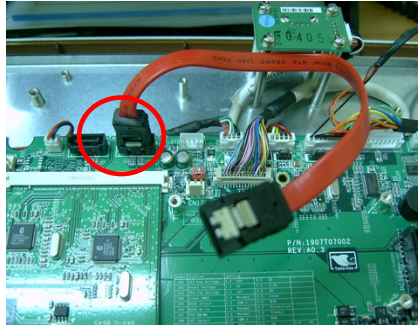

7. Insert the other side connector of SATA cable to the SATA port on HDD. In addition to connect the SATA cable, the power cable has to be connected to the HDD power socket as well.

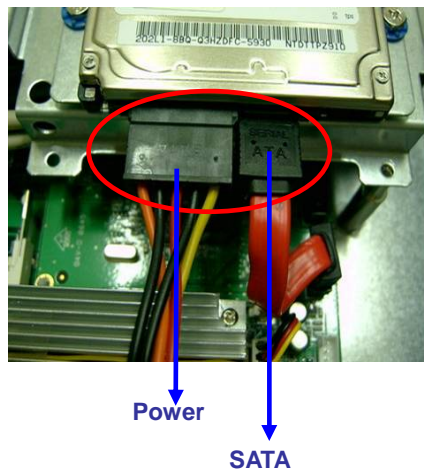

2.5 COM5 RS-232/422/485 Selection

COM5 RS-232/422/485 selection is set in BIOS setting as following.

Entering BIOS Setting Menu: Choose "Integrated Peripherals → Super IO device → COM5 select". (Default setting at "RS-232")

2.6 RS-232/422/485 Serial Port Connector

Different devices implement the RS-232/422/485 standard in different ways. If you are having problems with a serial device, be sure to check the pin assignments below for the connector.

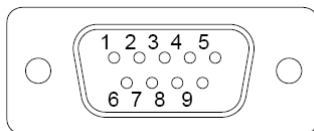

Pin	Signal	Pin	Signal
1	DCD (422TXD-/485DATA-)	2	RXD (422RXD+)
3	TXD (422TXD+/485DATA+)	4	DTR (422RXD-)
5	GND	6	DSR
7	RTS	8	CTS

Chapter

3

**Award
BIOS Setup**

3.1 System Test and Initialization

These routines test and initialize board hardware. If the routines encounter an error during the tests, you will either hear a few short beeps or see an error message on the screen. There are two kinds of errors: fatal and non-fatal. The system can usually continue the boot up sequence with non-fatal errors. Non-fatal error messages usually appear on the screen along with the following instructions:

Press <F1> to RESUME

Write down the message and press the F1 key to continue the boot up sequence.

System configuration verification

These routines check the current system configuration against the values stored in the CMOS memory. If they do not match, the program outputs an error message. You will then need to run the BIOS setup program to set the configuration information in memory.

There are three situations in which you will need to change the CMOS settings:

1. You are starting your system for the first time
2. You have changed the hardware attached to your system
3. The CMOS memory has lost power and the configuration information has been erased.

The ONYX-175S/195S CMOS memory has an integral lithium battery backup for data retention. However, you will need to replace the complete unit when it finally runs down.

3.2 Award BIOS Setup

Awards BIOS ROM has a built-in Setup program that allows users to modify the basic system configuration. This type of information is stored in battery-backed CMOS RAM so that it retains the Setup information when the power is turned off.

Entering setup

Power on the computer and press immediately. This will allow you to enter Setup.

Standard CMOS Features

Use this menu for basic system configuration. (Date, time, IDE, etc.)

Advanced BIOS Features

Use this menu to set the advanced features available on your system.

Advanced Chipset Features

Use this menu to change the values in the chipset registers and optimize your system performance.

Integrated Peripherals

Use this menu to specify your settings for integrated peripherals. (Primary slave, secondary slave, keyboard, mouse etc.)

Power Management Setup

Use this menu to specify your settings for power management. (HDD power down, power on by ring etc.)

PnP/PCI Configurations

This entry appears if your system supports PnP/PCI.

PC Health Status

This menu shows you the status of PC.

Frequency/Voltage Control

This menu shows you the display of frequency/Voltage Control.

Load Fail-Safe Defaults

Use this menu to load the BIOS default values for the minimal/ stable performance for your system to operate.

Load Optimized Defaults

Use this menu to load the BIOS default values that are factory settings for optimal performance system operations. While AWARD has designated the custom BIOS to maximize performance, the factory has the right to change these defaults to meet their needs.

Set Supervisor/User Password

Use this menu to set Supervisor/User Passwords.

Save and Exit Setup

Save CMOS value changes to CMOS and exit setup.

Exit Without Saving

Abandon all CMOS value changes and exit setup.

For more detailed information, you can refer to the "ONYX BIOS Item Description.pdf" file in the CD for the meaning of each setting in this chapter.

Chapter

4

**Driver
Installation**

There are several installation ways depending on the driver package under different Operating System application.

Please follow the sequence below to install the drivers:

- Step 1 – Install INF Driver
- Step 2 – Install VGA Driver
- Step 3 – Install Audio Driver
- Step 4 – Install LAN Driver
- Card Reader Driver Installation
- Touch Screen Driver Installation
- Smart Card Driver Installation
- RFID Driver Installation

USB 2.0 Drivers are available for download using Windows Update for both Windows XP and Windows 2000. For additional information regarding USB 2.0 support in Windows XP and Windows 2000, please visit www.microsoft.com/hwdev/usb/.

For installation procedures of each driver, you may see the details in the following.

4.1 Installation

Insert the ONYX-175/195 CD-ROM into the CD-ROM drive and install the drivers from Step 1 to Step 4 in order. (Other drivers will be optional).

Step 1 – Install INF Driver

1. Click on the **Step 1- INF driver** folder and double click on **infinst911_autol.exe**
2. Follow the instructions that the window shows
3. The system will help you install the driver automatically

Step 2 – Install VGA Driver

1. Click on the **Step 2 –VGA driver** folder and select the corresponding folder for your operating system and double click on **Setup.exe** file
2. Follow the instructions that the window shows
3. The system will help you install the driver automatically

Step 3 – Install Audio Driver

1. Click on the **Step 3 –AUDIO driver** folder and select the corresponding folder for your operating system and double click on **Setup.exe** file
2. Follow the instructions that the window shows
3. The system will help you install the driver automatically

Step 4 – Install Intel LAN Driver

1. Click on the **Step 4 – LAN driver** folder and select the **Winx32** folder and double click on **.exe** for x86 (32bit) OS; if the OS is Windows 64bit OS, please select the **Winx64** folder and double click on **.exe** file
2. Follow the instructions that the window shows
3. The system will help you install the driver automatically

4.2 Card Reader Driver Installation

1. Click on the **Card Reader** folder and then double click on the **Setup.exe**
2. Follow the instructions that the window shows you
3. The system will help you install the driver automatically

4.3 Touch Screen Driver Installation

1. Click on the **Touch driver** folder and select the corresponding folder for your operating system and double click on **Setup.exe** file
2. Follow the instructions that the window shows you
3. The system will help you install the driver automatically

4.4 Smart Card Driver Installation

1. Click on the **Smart card** folder and then double click on the **setup.exe**

2. Follow the instructions that the window shows you
3. The system will help you install the driver automatically

4.5 RFID Driver Installation

1. Click on the **RFID** folder and then double click on the **ISO15693.exe**
2. Follow the instructions that the window shows you
3. The system will help you install the driver automatically

Appendix

A

Programming the Watchdog Timer

A.1 Programming

ONYX-175S/195S utilizes ITE 8712 chipset as its watchdog timer controller.

Below are the procedures to complete its configuration and the ONYX initial watchdog timer program is also attached based on which you can develop customized program to fit your application.

Configuring Sequence Description

After the hardware reset or power-on reset, the ITE 8712 enters the normal mode with all logical devices disabled except KBC. The initial state (enable bit) of this logical device (KBC) is determined by the state of pin 121 (DTR1#) at the falling edge of the system reset during power-on reset.

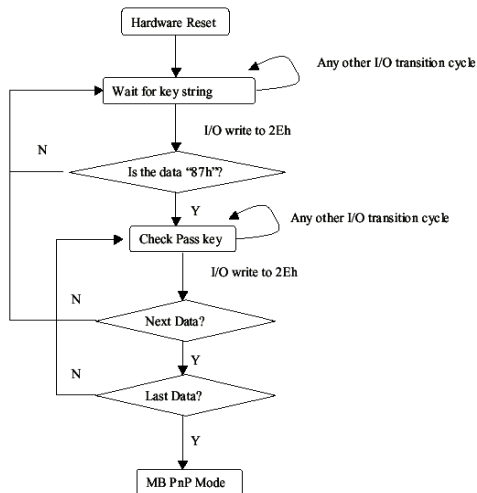

There are three steps to complete the configuration setup: (1) Enter the MB PnP Mode; (2) Modify the data of configuration registers; (3) Exit the MB PnP Mode. Undesired result may occur if the MB PnP Mode is not exited normally.

(1) Enter the MB PnP Mode

To enter the MB PnP Mode, four special I/O write operations are to be performed during Wait for Key state. To ensure the initial state of the key-check logic, it is necessary to perform four write operations to the Special Address port (2EH). Two different enter keys are provided to select configuration ports (2Eh/2Fh) of the next step.

	Address Port	Data Port
87h, 01h, 55h, 55h:	2Eh	2Fh

(2) Modify the Data of the Registers

All configuration registers can be accessed after entering the MB PnP Mode. Before accessing a selected register, the content of Index 07h must be changed to the LDN to which the register belongs, except some Global registers.

(3) Exit the MB PnP Mode

Set bit 1 of the configure control register (Index=02h) to 1 to exit the MB PnP Mode.

WatchDog Timer Configuration Registers

LDN	Index	R/W	Reset	Configuration Register or Action
All	02H	W	N/A	Configure Control
07H	71H	R/W	00H	WatchDog Timer Control Register
07H	72H	R/W	00H	WatchDog Timer Configuration Register
07H	73H	R/W	00H	WatchDog Timer Time-out Value Register

Configure Control (Index=02h)

This register is write only. Its values are not sticky; that is to say, a hardware reset will automatically clear the bits, and does not require the software to clear them.

Bit	Description
7-2	Reserved
1	Returns to the Wait for Key state. This bit is used when the configuration sequence is completed
0	Resets all logical devices and restores configuration registers to their power-on states.

WatchDog Timer Control Register (Index=71h, Default=00h)

Bit	Description
7	WDT is reset upon a CIR interrupt
6	WDT is reset upon a KBC (mouse) interrupt
5	WDT is reset upon a KBC (keyboard) interrupt
4	WDT is reset upon a read or a write to the Game Port base address
3-2	Reserved
1	Force Time-out. This bit is self-clearing
0	WDT Status
	1: WDT value reaches 0.
	0: WDT value is not 0

WatchDog Timer Configuration Register (Index=72h,

Default=00h)

Bit	Description
7	WDT Time-out value select
	1: Second
	0: Minute
6	WDT output through KRST (pulse) enable
5-4	Reserved
3-0	Select the interrupt level ^{Note} for WDT

WatchDog Timer Time-out Value Register (Index=73h,

Default=00h)

Bit	Description
7-0	WDT Time-out value 7-0

A.2 IT8712 Watchdog Timer Initial Program

```
.MODEL SMALL
```

```
.CODE
```

Main:

```
CALL Enter_Configuration_mode
```

```
CALL Check_Chip
```

```
mov cl, 7
```

```
call Set_Logic_Device
```

```
;time setting
```

```
mov cl, 10 ; 10 Sec
```

```
dec al
```

Watch_Dog_Setting:

```
;Timer setting
```

```
mov al, cl
```

```
mov cl, 73h
```

```
call Superio_Set_Reg
```

```
;Clear by keyboard or mouse interrupt
```

```
mov al, 0f0h
```

```
mov cl, 71h
```

```
call Superio_Set_Reg
```

```
;unit is second.
```

```
mov al, 0C0H
```

```
mov cl, 72h
```

```
call Superio_Set_Reg
```

```
; game port enable  
mov cl, 9  
call Set_Logic_Device
```

```
Initial_OK:  
CALL Exit_Configuration_mode  
MOV AH,4Ch  
INT 21h
```

```
Enter_Configuration_Mode PROC NEAR  
MOV SI,WORD PTR CS:[Offset Cfg_Port]
```

```
MOV DX,02Eh  
MOV CX,04h  
Init_1:  
MOV AL,BYTE PTR CS:[SI]  
OUT DX,AL  
INC SI  
LOOP Init_1  
RET  
Enter_Configuration_Mode ENDP
```

```
Exit_Configuration_Mode PROC NEAR  
MOV AX,0202h  
CALL Write_Configuration_Data
```

RET

Exit_Configuration_Mode ENDP

Check_Chip PROC NEAR

MOV AL,20h

CALL Read_Configuration_Data

CMP AL,87h

JNE Not_Initial

MOV AL,21h

CALL Read_Configuration_Data

CMP AL,12h

JNE Not_Initial

Need_Initial:

STC

RET

Not_Initial:

CLC

RET

Check_Chip ENDP

Read_Configuration_Data PROC NEAR

MOV DX,WORD PTR CS:[Cfg_Port+04h]

OUT DX,AL

```
MOV DX,WORD PTR CS:[Cfg_Port+06h]
IN AL,DX
RET
Read_Configuration_Data ENDP
```

```
Write_Configuration_Data PROC NEAR
MOV DX,WORD PTR CS:[Cfg_Port+04h]
OUT DX,AL
XCHG AL,AH
MOV DX,WORD PTR CS:[Cfg_Port+06h]
OUT DX,AL
RET
Write_Configuration_Data ENDP
```

```
Superio_Set_Reg proc near
push ax
MOV DX,WORD PTR CS:[Cfg_Port+04h]
mov al,cl
out dx,al
pop ax
inc dx
out dx,al
ret
Superio_Set_Reg endp.Set_Logic_Device proc near
Set_Logic_Device proc near
```

```
push ax
push cx
xchg al,cl
mov cl,07h
call Superio_Set_Reg
pop cx
pop ax
ret
Set_Logic_Device endp

;Select 02Eh->Index Port, 02Fh->Data Port
Cfg_Port DB 087h,001h,055h,055h

DW 02Eh,02Fh
```

END Main

Note: Interrupt level mapping

0Fh-Dh: not valid

0Ch: IRQ12

.

.

03h: IRQ3

02h: not valid

01h: IRQ1

00h: no interrupt selected

Appendix

B

I/O Information

B.1 I/O Address Map

AA-6DA46CFESFC9

- Direct memory access (DMA)
- Input/output (IO)
 - [00000000 - 0000000F] Direct memory access controller
 - [00000000 - 00000CF7] PCI bus
 - [00000010 - 0000001F] Motherboard resources
 - [00000020 - 00000021] Programmable interrupt controller
 - [00000022 - 0000003F] Motherboard resources
 - [00000040 - 00000043] System timer
 - [00000044 - 0000005F] Motherboard resources
 - [00000060 - 00000060] Standard 101/102-Key or Microsoft Natural PS/2 Keyboard
 - [00000061 - 00000061] System speaker
 - [00000062 - 00000063] Motherboard resources
 - [00000064 - 00000064] Standard 101/102-Key or Microsoft Natural PS/2 Keyboard
 - [00000065 - 0000006F] Motherboard resources
 - [00000070 - 00000073] System CMOS/real time clock
 - [00000074 - 0000007F] Motherboard resources
 - [00000080 - 00000090] Direct memory access controller
 - [00000091 - 00000093] Motherboard resources
 - [00000094 - 0000009F] Direct memory access controller
 - [000000A0 - 000000A1] Programmable interrupt controller
 - [000000A2 - 000000BF] Motherboard resources
 - [000000C0 - 000000DF] Direct memory access controller
 - [000000E0 - 000000EF] Motherboard resources
 - [000000F0 - 000000FF] Numeric data processor
 - [000001F0 - 000001F7] Primary IDE Channel
 - [00000274 - 00000277] ISAPNP Read Data Port
 - [00000279 - 00000279] ISAPNP Read Data Port
 - [00000290 - 0000029F] Motherboard resources
 - [000002E0 - 000002E7] Communications Port (COM5)
 - [000002E8 - 000002EF] Communications Port (COM4)
 - [000002F0 - 000002F7] Communications Port (COM6)
 - [000002F8 - 000002FF] Communications Port (COM2)
 - [00000378 - 0000037F] Printer Port (LPT1)
 - [000003B0 - 000003BF] Mobile Intel(R) 945GM Express Chipset Family
 - [000003C0 - 000003DF] Mobile Intel(R) 945GM Express Chipset Family
 - [000003E8 - 000003EF] Communications Port (COM3)
 - [000003F6 - 000003F6] Primary IDE Channel
 - [000003F8 - 000003FF] Communications Port (COM1)
 - [00000400 - 000004BF] Motherboard resources
 - [000004D0 - 000004D1] Motherboard resources
 - [00000500 - 0000051F] Intel(R) 82801 G (ICH7 Family) SMBus Controller - 27DA
 - [00000800 - 0000087F] Motherboard resources
 - [00000A79 - 00000A79] ISAPNP Read Data Port
 - [00000D00 - 0000FFFF] PCI bus
 - [00009000 - 00009FFF] Intel(R) 82801 G (ICH7 Family) PCI Express Root Port - 27D0
 - [00009F00 - 00009F1F] Intel(R) PRO/1000 PL Network Connection #2
 - [00008000 - 00008FFF] Intel(R) 82801 G (ICH7 Family) PCI Express Root Port - 27D6
 - [0000C000 - 0000CFFF] Intel(R) 82801 G (ICH7 Family) PCI Express Root Port - 27D4
 - [0000D000 - 0000DFFF] Intel(R) 82801 G (ICH7 Family) PCI Express Root Port - 27D2
 - [0000DF00 - 0000DF1F] Intel(R) PRO/1000 PL Network Connection
 - [0000F000 - 0000F0FF] Realtek AC'97 Audio
 - [0000F300 - 0000F30F] Intel(R) 82801 GBM/GHM (ICH7-M Family) Serial ATA Storage Controller - 27C4
 - [0000F400 - 0000F403] Intel(R) 82801 GBM/GHM (ICH7-M Family) Serial ATA Storage Controller - 27C4
 - [0000F500 - 0000F507] Intel(R) 82801 GBM/GHM (ICH7-M Family) Serial ATA Storage Controller - 27C4
 - [0000F600 - 0000F603] Intel(R) 82801 GBM/GHM (ICH7-M Family) Serial ATA Storage Controller - 27C4
 - [0000F700 - 0000F707] Intel(R) 82801 GBM/GHM (ICH7-M Family) Serial ATA Storage Controller - 27C4
 - [0000F800 - 0000F80F] Intel(R) 82801 G (ICH7 Family) Ultra ATA Storage Controllers - 27DF
 - [0000FA00 - 0000FA3F] Realtek AC'97 Audio
 - [0000FB00 - 0000FB1F] Intel(R) 82801 G (ICH7 Family) USB Universal Host Controller - 27CB
 - [0000FC00 - 0000FC1F] Intel(R) 82801 G (ICH7 Family) USB Universal Host Controller - 27CA
 - [0000FD00 - 0000FD1F] Intel(R) 82801 G (ICH7 Family) USB Universal Host Controller - 27C9
 - [0000FE00 - 0000FE1F] Intel(R) 82801 G (ICH7 Family) USB Universal Host Controller - 27C8
 - [0000FF00 - 0000FF07] Mobile Intel(R) 945GM Express Chipset Family

Interrupt request (IRQ)

Memory

B.2 Memory Address Map

AA-6DA46CFE5FC9	
+	Direct memory access (DMA)
+	Input/output (IO)
+	Interrupt request (IRQ)
+	Memory
+	[00000000 - 0009FFFF] System board
+	[000A0000 - 000BFFFF] Mobile Intel(R) 945GM Express Chipset Family
+	[000A0000 - 000BFFFF] PCI bus
+	[000C0000 - 000DFFFF] PCI bus
+	[000CE600 - 000CFFFF] System board
+	[000E0000 - 000EFFFF] System board
+	[000F0000 - 000F7FFF] System board
+	[000F8000 - 000FBFFF] System board
+	[000FC000 - 000FFFFF] System board
+	[00100000 - 1F6DFFFF] System board
+	[1F6E0000 - 1F6FFFFF] System board
+	[1F700000 - FEBFFFFF] PCI bus
+	[D0000000 - DFFFFFFF] Mobile Intel(R) 945GM Express Chipset Family
+	[E0000000 - EFFFFFFF] Motherboard resources
+	[FD400000 - FD4FFFFF] Intel(R) 82801G (ICH7 Family) PCI Express Root Port - 27D2
+	[FD500000 - FD5FFFFF] Intel(R) 82801G (ICH7 Family) PCI Express Root Port - 27D2
+	[FD5E0000 - FD5FFFFF] Intel(R) PRO/1000 PL Network Connection
+	[FD600000 - FD6FFFFF] Intel(R) 82801G (ICH7 Family) PCI Express Root Port - 27D0
+	[FD900000 - FD9FFFFF] Intel(R) 82801G (ICH7 Family) PCI Express Root Port - 27D0
+	[FD9E0000 - FD9FFFFF] Intel(R) PRO/1000 PL Network Connection #2
+	[FDA00000 - FDAFFFFF] Intel(R) 82801G (ICH7 Family) PCI Express Root Port - 27D6
+	[FDB00000 - FDBFFFFF] Intel(R) 82801G (ICH7 Family) PCI Express Root Port - 27D6
+	[FDC00000 - FDCFFFFF] Intel(R) 82801G (ICH7 Family) PCI Express Root Port - 27D4
+	[FDD00000 - FDDFFFFF] Intel(R) 82801G (ICH7 Family) PCI Express Root Port - 27D4
+	[FDE80000 - FDEFFFFF] Mobile Intel(R) 945GM Express Chipset Family
+	[FDF00000 - FDF7FFFF] Mobile Intel(R) 945GM Express Chipset Family
+	[FDF80000 - FDFBFFFF] Mobile Intel(R) 945GM Express Chipset Family
+	[FDFFC000 - FDFFC3FF] Intel(R) 82801GBM/GHM (ICH7-M Family) Serial ATA Storage Controller - 27C4
+	[FDFFD000 - FDFFD0FF] Realtek AC'97 Audio
+	[FDFFE000 - FDFFE1FF] Realtek AC'97 Audio
+	[FDFFF000 - FDFFF3FF] Intel(R) 82801G (ICH7 Family) USB2 Enhanced Host Controller - 27CC
+	[FEC00000 - FEC00FFF] System board
+	[FED13000 - FED1DFFF] System board
+	[FED20000 - FED8FFFF] System board
+	[FEE00000 - FEE00FFF] System board
+	[FFB00000 - FFB7FFFF] System board
+	[FFB80000 - FFBFFFFF] Intel(R) 82802 Firmware Hub Device
+	[FFF00000 - FFFFFFFF] System board

B.3 IRQ Mapping Chart

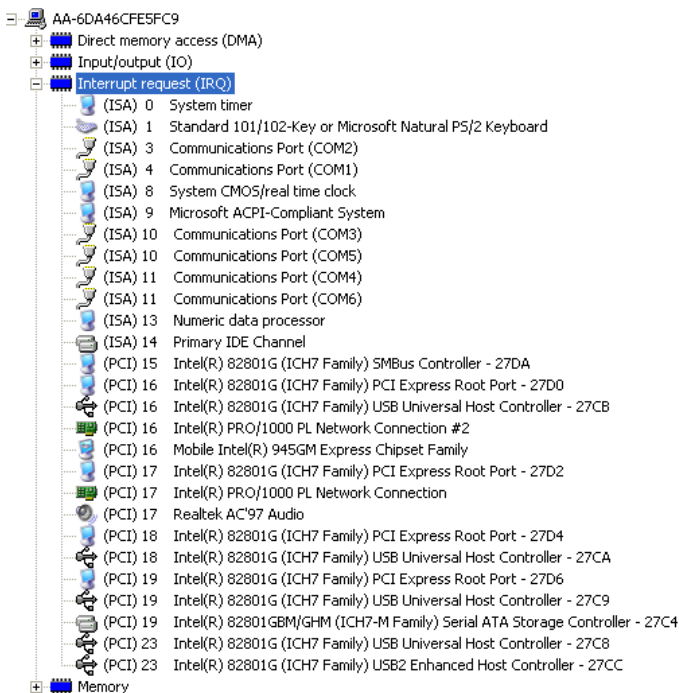

B.4 DMA Channel Assignments



Appendix

C

Miscellanea

C.1 General Cleaning Tips

You may need the following precautions before you begin to clean the computer. When you clean any single part or component for the computer, please read and understand the details below fully.

1. Never spray or squirt the liquids directly onto any computer component. If you need to clean the device, please rub it with a piece of dry cloth.
2. Be cautious of the tiny removable components when you use a vacuum cleaner to absorb the dirt on the floor.
3. Turn the system off before you start to clean up the component or computer.
4. Never drop the components inside the computer or get circuit board damp or wet.
5. Be cautious of all kinds of cleaning solvents or chemicals when you use it for the sake of cleaning. Some individuals may be allergic to the ingredients.
6. Try not to put any food, drink or cigarette around the computer.

C.2 Cleaning tools

Although many companies have created products to help improve the process of cleaning your computer and peripherals users can also use household items to clean their computers and peripherals. Below is a listing of items you may need or want to use while cleaning your computer or computer peripherals.

Keep in mind that some components in your computer may only be able to be cleaned using a product designed for cleaning that component, if this is the case it will be mentioned in the cleaning tips.

- **Cloth** - A piece of cloth is the best tool to use when rubbing up a component. Although paper towels or tissues can be used on most hardware as well, we still recommend you to rub it with a piece of cloth.
- **Water or rubbing alcohol** – You may moisten a piece of cloth a bit with some water or rubbing alcohol and rub it on the computer. Unknown solvents may be harmful to the plastics parts.
- **Vacuum cleaner** - Absorb the dust, dirt, hair, cigarette particles, and other particles out of a computer can be one of the best methods of cleaning a computer. Over time these items can restrict the airflow in a computer and cause circuitry to corrode.

- **Cotton swabs** - Cotton swabs moistened with rubbing alcohol or water are excellent tools for wiping hard to reach areas in your keyboard, mouse, and other locations.
- **Foam swabs** - Whenever possible it is better to use lint free swabs such as foam swabs.

Note:

We strongly recommended that you should shut down the system before you start to clean any single components.

Please follow the steps below.

1. Close all application programs.
2. Close operating software.
3. Turn off power switch
4. Remove all device
5. Pull out power cable

C.3 Scrap Computer Recycling

If the computer equipments need the maintenance or are beyond repair, we strongly recommended that you should inform us as soon as possible for the suitable solution. For the computers that are no longer useful or work well, please contact with worldwide distributors for recycling.

The worldwide distributors show on the following website:

<http://www.onyx-healthcare.com.tw/Contact.php>

Note:

Follow the national requirement to dispose unit