

Medical Power Panel PC

Venus-123

11.6" Intel i7/i5/i3 Medical Panel PC with Dual Battery

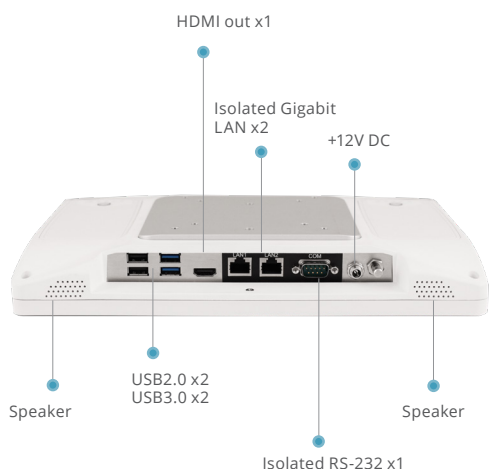
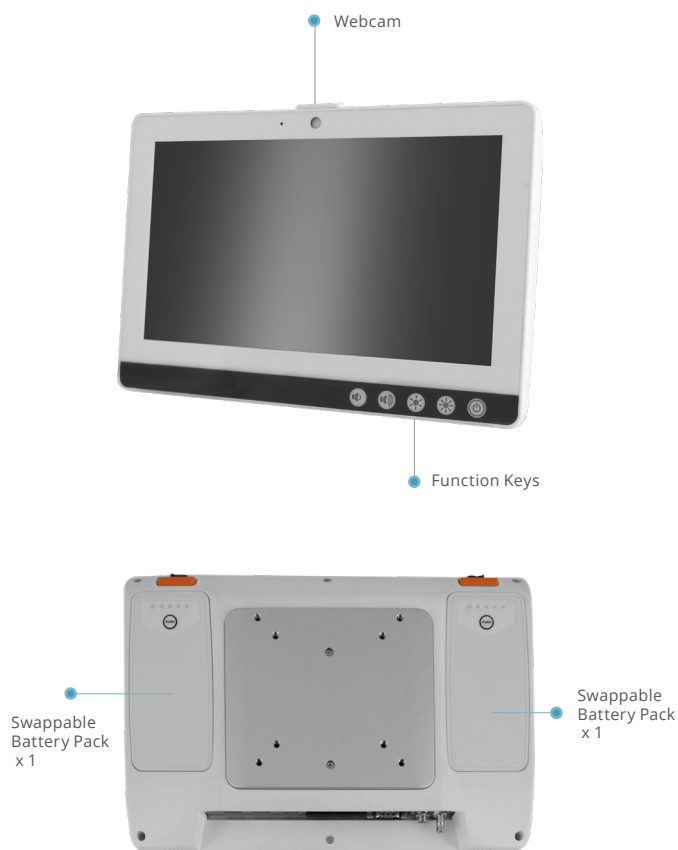

Features

- Highest level of medical safety protection , EMC4.0/ Safety 3.1
- Cleanability with hospital solvents
- Hot swappable design, support 24/7 run time
- Intel® Skylake Dual-Core i5
- Support remote monitor/control/update (ORION compatible)
- isolated LAN / COM port

Specifications

Main Specifications

Processor	Intel® Skylake Dual-Core i5 /Celeron 3955U
System Memory	DDR4 up to 16GB
OS Support	Microsoft® Windows 7 Microsoft® Windows 8.1 Microsoft® Windows 10 Ubuntu 18.04 LTS IGEL (thin client solution)
Graphics	Intel® HD Graphics 520
Storage	M.2 SSD up to 512GB (optional)
Wireless Communication	802.11 ac/a/b/g/n + BT 4.0 (optional)
Touch	Project Capacitive Touch / Resistive Touch
Speaker	2W x2
Security	TPM 2.0

Display

Display Size	11.6"
Resolution	1366 x 768
Max. Colors	262K
Contrast Ratio	500:1
Luminance (cd/m2)	250

I/O

USB	USB 3.0 x2, USB 2.0 x2
Video Out	HDMI out x1
COM	COM port x1
Ethernet	Gigabit LAN x 2
DC-in	12V DC-in x1

Mechanical and Environmental

VESA	75/100 mm VESA mount
Operating Temperature	0°C ~ 35°C(32°F ~ 95°F)
Storage Temperature	-20°C ~ 60°C(-4°F ~ 140°F)
Storage Humidity	10%~95%@40°C, non-condensing
Degree of Protection	Front Panel: IP65 ; Rear: IPX1
Dimension	300(L) x 43(W) x 205(H) mm
Net Weight	1.9kg
Packing Size	420(L) x 185(W) x 345(H) mm
Gross Weight	2.6 Kg
Certifications	CE: EN 60601-1-2:2015(V4.0), EN 60601-1:2006/ A1:2013(V3.1) FCC: Part 18 Class B UL: ANSI/AAMI ES60601-1:2012 (V3.1) cUL: CAN/CSA-C22.2 No. 60601-1:2014 (V3.1)

ALL PRODUCT, PRODUCT SPECIFICATIONS AND DATA ARE SUBJECT TO CHANGE WITHOUT NOTICE TO IMPROVE RELIABILITY, FUNCTION OR DESIGN OR OTHERWISE.

11.6" Intel i7/i5/i3 Medical Panel PC with Dual Battery

Dimension / Unit: mm

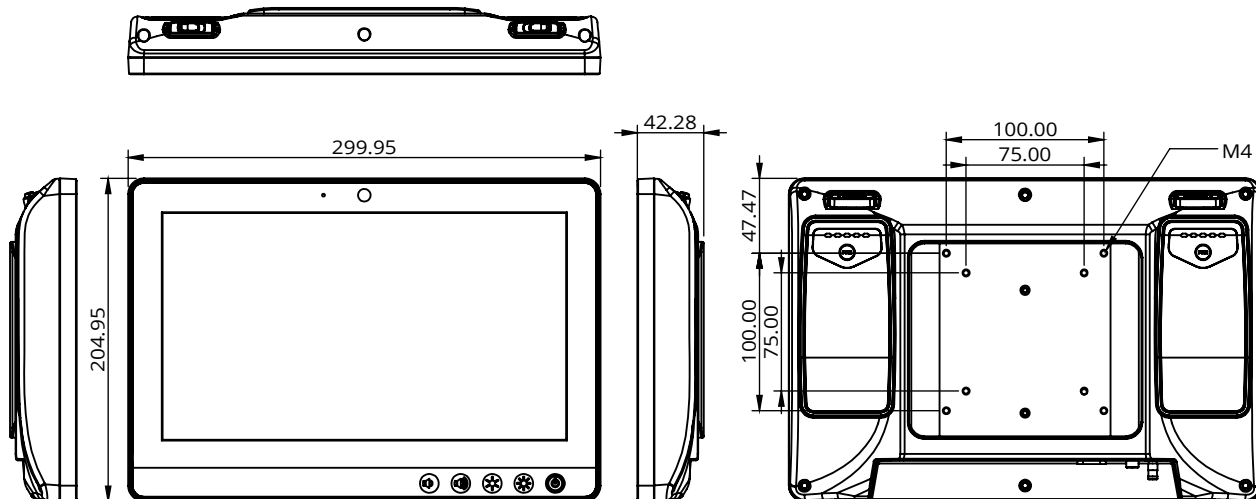

Ordering Information

- » VENUS-123-R62-A1-0001
Mobile Computer , i5 6200U ,11.6" Fanless, R-TS . TPM . Battery x 2
- » VENUS-123-P62-A1-0001
Mobile Computer , i5 6200U ,11.6" Fanless, Pcap . TPM . Battery x 2
- » VENUS-123-P39-A1-0001
Mobile Computer ,3955U ,11.6" Fanless, Pcap . TPM . Battery x 2

Optional Accessories

- » 1757306039
Medical Adaptor , 12V/60W
- » OPM-C10W-A4
WLAN dual band module kits , Intel 802.11 ac/a/b/g/n + BT 4.2
- » OPM-C12W-A4
WLAN dual band module kits , Atheros 802.11 a/b/g/n/ac+ BT 4.1
- » UP-M62-A1-1010
6-Slot Charger + 24V / 120W adaptor
- » OPM-V01C-03
2MP Camera Kit with Mic