

Medical Power Panel PC

Venus-173

17" Intel i7/i5/i3 Medical Panel PC with Dual Battery

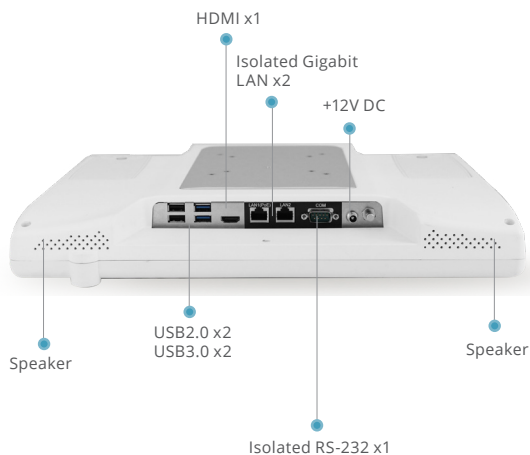

Features

- Highest level of medical safety protection , EMC4.1/ Safety 3.2
- Cleanability with hospital solvents
- Hot swappable design, support 24/7 run time
- Intel® Skylake Dual-Core i5
- Support remote monitor/control/update (ORION compatible)
- isolated LAN / COM port

Specifications

MAIN SPECIFICATIONS

Processor	Intel® Skylake Dual-Core i5
System Memory	DDR4 up to 16GB
OS Support	Microsoft® Windows 7 (32bit/64bit) Microsoft® Windows 8.1 (64bit) Microsoft® Windows 10 (64bit) Ubuntu 18.04 LTS IGEL (thin client solution)
Graphics	Intel® HD Graphics 520
Storage	M.2 SSD up to 512GB (optional)
Wireless Communication	802.11 ac/a/b/g/n + BT 4.0 (optional)
Touch	R-TS
Speaker	3W x2
Security	TPM 2.0

DISPLAY

Display Size	17"
Resolution	1280 x 1024
Max. Colors	16.7M
Contrast Ratio	1000:1
Luminance (cd/m2)	250

I/O

USB	USB 3.0 x2, USB 2.0 x2
Video Out	HDMI 1.4 x1
COM	COM port x1
Ethernet	Gigabit LAN x 2
DC-in	12V DC-in x1

MECHANICAL AND ENVIRONMENTAL

VESA	75/100 mm VESA mount
Operating Temperature	0°C ~ 35°C(32°F ~ 95°F)
Storage Temperature	-20°C ~ 60°C(-4°F ~ 140°F)
Storage Humidity	10%~95%@40°C, non-condensing
Degree of Protection	IPX1
Dimension	384(L) x 57(W) x 345(H) mm
Net Weight	4.5kg
Packing Size	510(L) x 200(W) x 480(H) mm
Gross Weight	5.6 Kg
Certifications	CE : EN 60601-1-2: 2015 + A1: 2021 (V4.1), EN 60601-1: 2007 + A1:2013 +A2:2021 (V3.2) EN 55032:2015/A1:2020 EN55035:2017/A11:2020(ITE) IEC62368-1:2020+A11:2020 (ITE) FCC : Part 15B/ Part 18 UL : ANSI AAMI ES60601-1:2005/A1:2012/A2:2021(V3.2) cUL : CAN/CSA-C22.2 No. 60601-1:14 (IEC 60601-1: 2005+A1:2012+A2:2020,MOD) (V3.2) TELEC :JAPAN TELEC

ALL PRODUCT, PRODUCT SPECIFICATIONS AND DATA ARE SUBJECT TO CHANGE WITHOUT NOTICE TO IMPROVE RELIABILITY, FUNCTION OR DESIGN OR OTHERWISE.

17" Intel i7/i5/i3 Medical Panel PC with Dual Battery

Dimension / Unit: mm

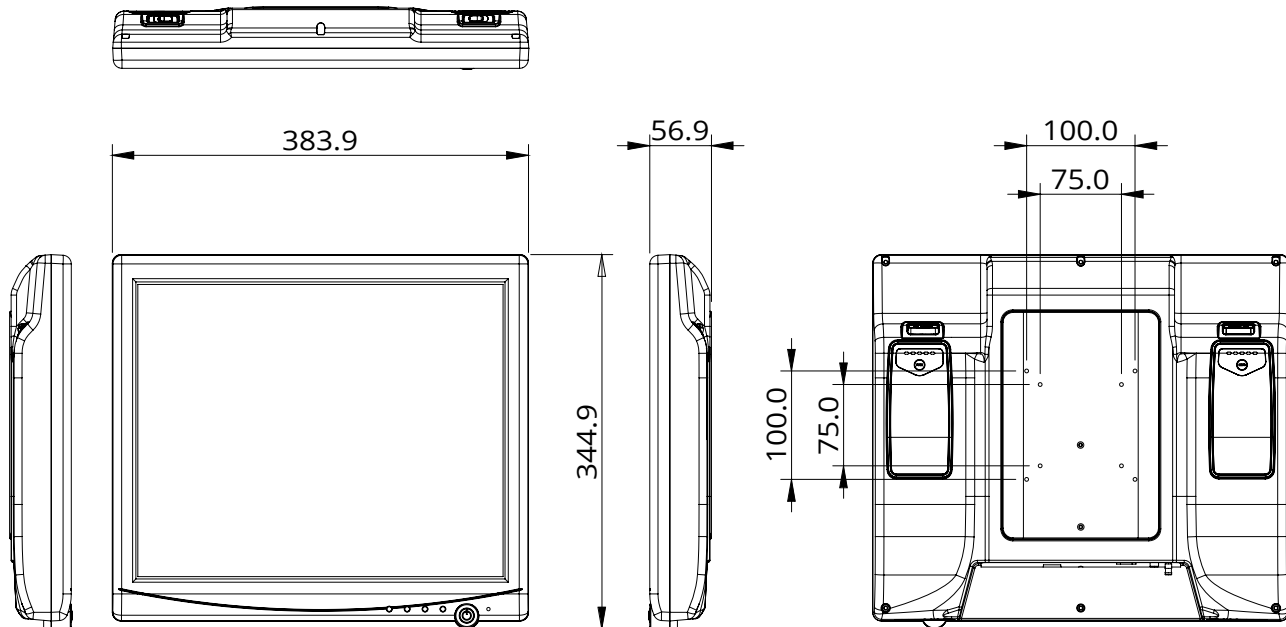

Ordering Information

- VENUS-173-R63-A1-0001
Mobile Computer , i5 6300U ,17" Fanless, R-TS . TPM . Battery x 2

Optional Accessories

- 1757306039
Medical Adaptor , 12V/60W
- OPM-C15W-A5
WLAN dual band module Kit.Intel 802.11a/b/g/n/ac+BT 5
- UP-M62-A1-1010
6-Slot Charger + 24V / 120W adaptor